

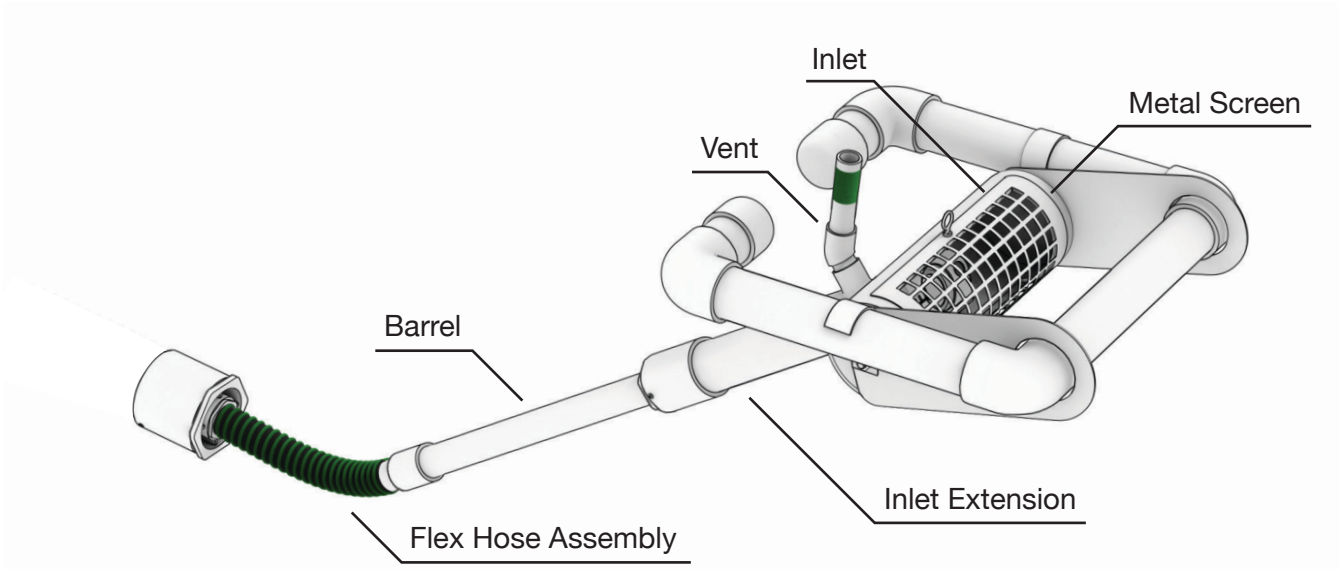

8

Faircloth Skimmer®

Instructions for Assembly



INCLUDED

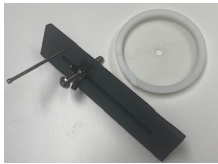

Cutting Tool and Orifice Plate



Inlet Extension

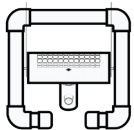

Pre-assembled Skimmer



Flex Hose Assembly



Vent



Connection Kit



Rope

NOT INCLUDED



Engineering Plans



6" Sch 40 solid PVC (6' or longer) for Barrel



PVC Pipe Primer and Glue



Phillips Head Screwdriver



Measuring Tool

For more information visit FairclothSkimmer.com or call us at (919)732-1244.

STEP 1

Adjust Orifice Opening

Note: Reference your site engineering plans for correct sizing.

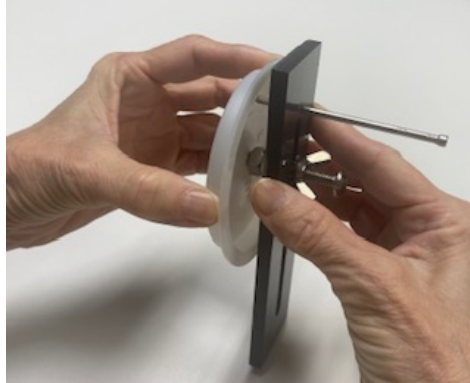

1A. Open the metal screen and remove the orifice plate from the inlet. Measuring from the cutting nail to the bolt, adjust the orifice cutting tool to the correct radius (orifice diameter divided by 2) and tighten the nut.

1B. Insert the bolt of the orifice cutting tool into the orifice plate and apply pressure as you turn the orifice plate against the cutting nail. This may take a few turns of the orifice plate against the cutting nail before it cuts through.

1C. Reinstall the orifice plate in the inlet and tighten screw to secure the orifice plate. Close the metal screen and secure with attached eye screw.

STEP 2

Install Inlet Extension and Vent

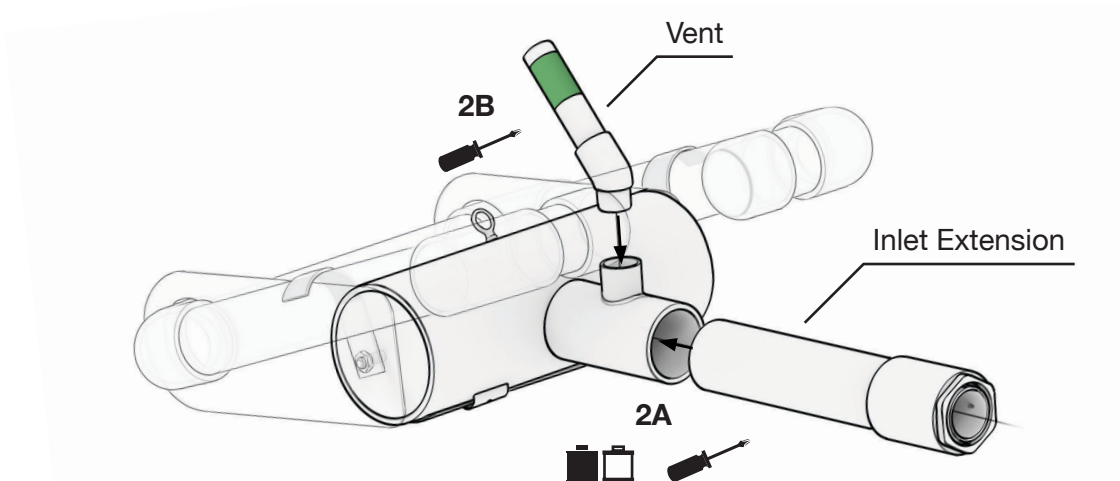

2A. If you don't plan on disassembling the skimmer for future use, prime and glue the inlet extension to the inlet as shown in the image. If you do plan on disassembling, screw it in place.

2B. Install the short end of the vent tube into the tee, as shown in the image. You may have to back out the screw before installing and tighten once the vent tube is in place.

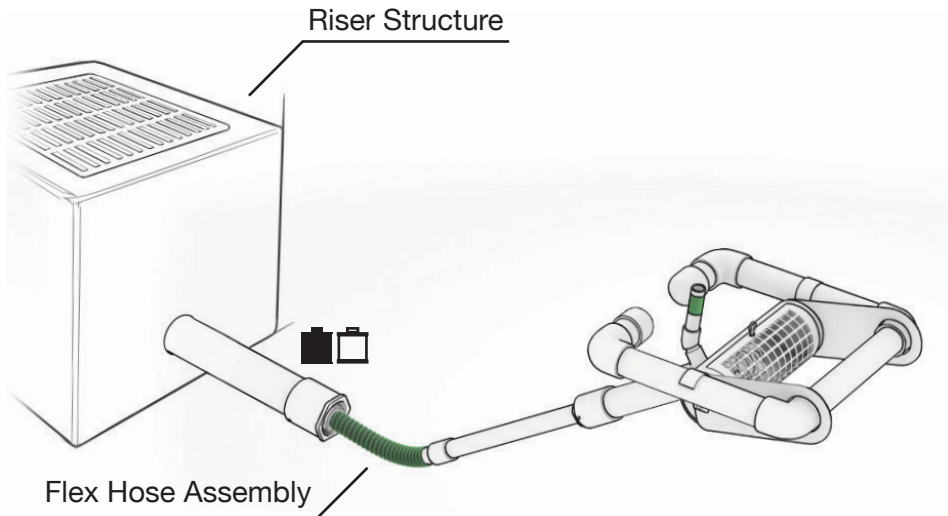
STEP 3**Connect to Outlet**

3. The Connection Kit comes with a variety of fittings that can be used depending on site conditions. Use the appropriate components to connect the Flex Hose Assembly to the outlet with primer and glue

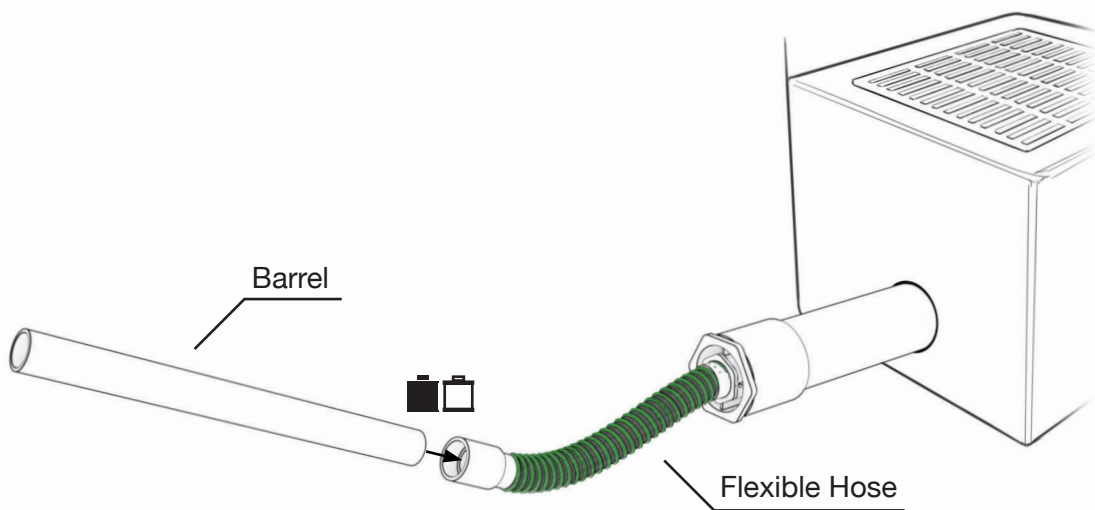
STEP 4**Cut and Attach Barrel**

Note: Barrel length should be 1.4 times the depth of the basin (distance from basin bottom to spillway) but not shorter than 6'.

4A. Cut the 6" PVC pipe to proper length to create the barrel.

4B. Prime and glue the barrel to the Flex Hose Assembly, as shown in the image above.

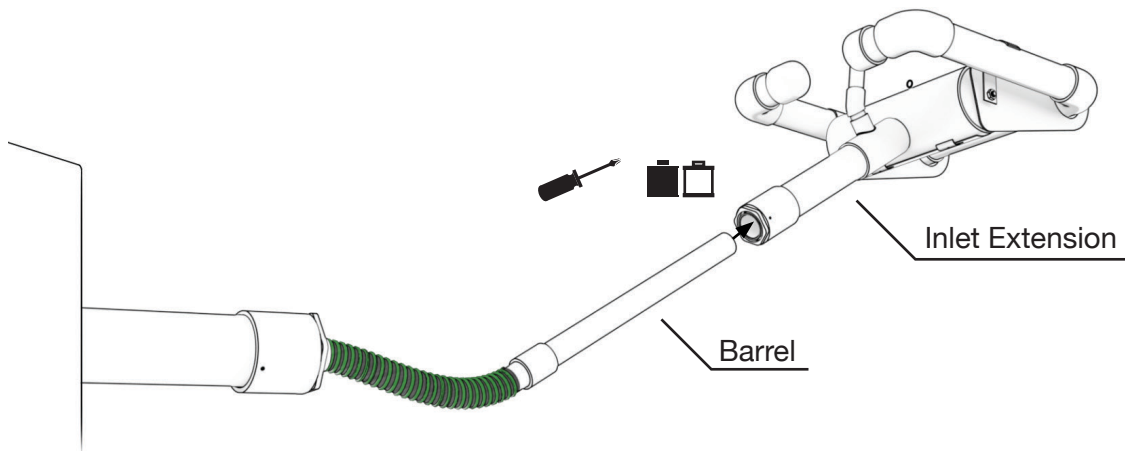
STEP 5**Attach Skimmer to Barrel**

5A. Fully insert the barrel into the inlet extension. Primer and glue can be used here if preferred.

5B. Tighten the screw until it pushes against the barrel to secure it.

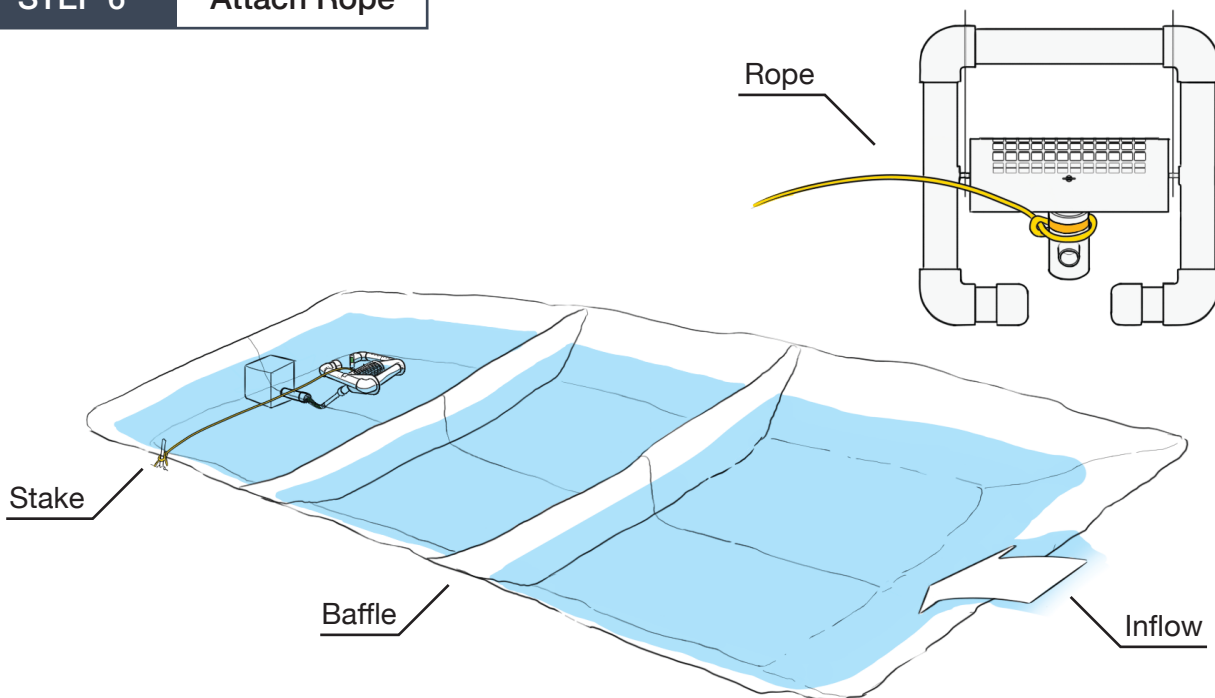
STEP 6**Attach Rope**

6A. Attach the rope to the skimmer, as shown in the image, at the yellow sticker.

6B. Attach the other end of the rope to a stake on the side of the basin.